



The Leader in Architectural Audio™

PN. 33-2295

## INTRODUCTION

Thank you for purchasing Sonance Virtuoso P800D in-wall woofer. When properly installed, this product will provide you with years of entertainment pleasure.

To obtain the full potential of your new speaker, please read all instructions before starting the installation. If you do not have the necessary skills to install the speakers yourself, contact your authorized Sonance dealer for installation options.

## OPTIONAL ACCESSORIES

**Fix Depth Bracket** - part number 91707  
Plastic template to reserve hole in new construction.

**Coverplate** - part number 90-0731  
Designed to cover hole made by Fixed Depth Bracket until the speaker is installed.

## PARTS LIST

Each Virtuoso P800D includes the following items:

- (1) Sonance Virtuoso P800D speaker
- (1) Paintable grille
- (1) Plastic paint plug to protect speaker during painting
- (1) Mounting cutout template ( in packaging )

## INSTALLATION INSTRUCTIONS

### SONANCE VIRTUOSO™ A800D IN-WALL WOOFER

#### HOME THEATER PLACEMENT

For best performance the Virtuoso A800D woofer should be placed in the front corner of the room as shown in the illustration below. Keep the woofer as close as possible to the left, center and right speakers to assure seamless integration of the sound from the main speaker and the woofer.

The woofer should not be mounted in the same stud bay as the left or right speakers.

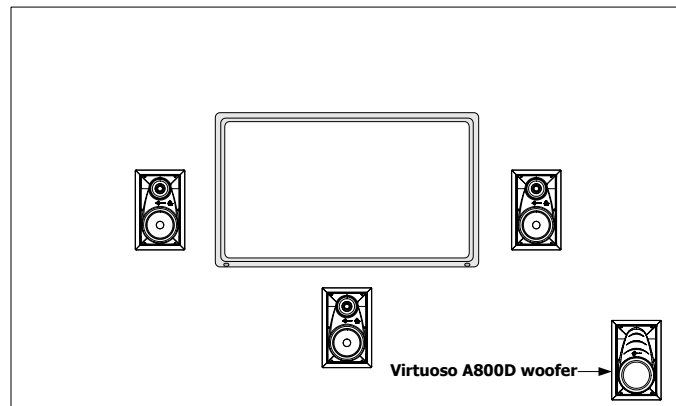

**Home Theater Placement**

#### 2 - CHANNEL AUDIO PLACEMENT

In a two channel system the woofer should be located in a corner of the room and as close as possible to the left or right speaker. Corner placement of the woofer will provide more predictable performance and higher output level.

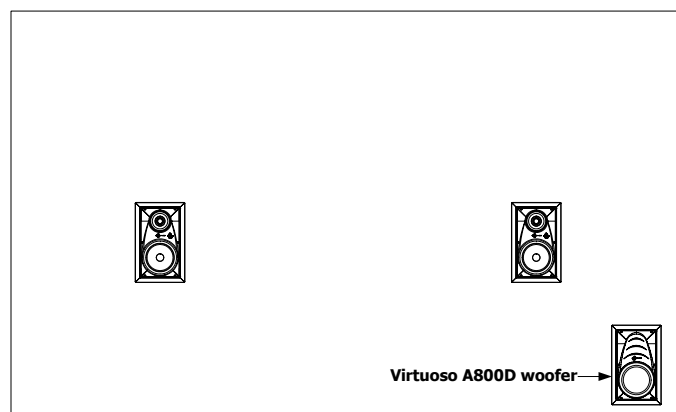

**Two Channel Audio Placement**

## WIRE GAUGE AND QUALITY

The total wire resistance should be less than 10% of the speaker impedance. If using an 8 ohm speaker, your total wire resistance should be no more than 0.8 ohms.

In simple terms, the extra resistance from the wire will have a very negative affect on the sound quality of the speaker. The sound can be less dynamic, definition of bass frequencies can be reduced. Amplifier power is also wasted in the wire, reducing the maximum output level of the system.

Please refer to the following chart when deciding on the appropriate wire gauge for your installation.

Wire resistance in Ohms vs. length of cable run						
Distance in Feet	50'	100'	150'	200'	250'	300'
<b>20 gauge</b>	.86	1.73	2.59	3.45	4.32	5.18
<b>18 gauge</b>	.65	1.30	1.94	2.59	3.24	3.89
<b>16 gauge</b>	.43	.85	1.28	1.71	2.14	2.56
<b>14 gauge</b>	.27	.54	.81	1.08	1.35	1.62
<b>12 gauge</b>	.17	.34	.51	.68	.85	1.02
<b>10 gauge</b>	.11	.22	.33	.44	.56	.67

## OPTIONAL ACCESSORIES

**Fix Depth Bracket** - part number 91707  
Plastic template to reserve hole in new construction.

**Coverplate** - part number 90-0731  
Designed to cover hole made by Fixed Depth Bracket until the speaker is installed.

## PREPARING THE INSTALLATION LOCATION

All Sonance speakers are designed to be relatively insensitive to changes in enclosure volume. To achieve the ultimate performance from the Virtuoso P800D speaker, a section of the wall stud bay can be sectioned off to form a back box. Building this enclosure will create a dramatic improvement in the quality of bass response and power handling.

Back box volume requirement:  
P800D 1.50 cubic feet (45.5 liters)

### Insulating the wall cavity

Speaker performance can be enhanced by insulating the cavity with fiberglass insulation.

When installing speakers in a wall, it is best to install a sheet of unfaced fiberglass insulation behind and around the back of the speaker.

To further improve the sound quality, install insulation in the bays adjacent to the speaker location. This will reduce noise produced by the unsupported drywall.

## Sonafill™

Sonafill is a retrofitable acoustical treatment for loudspeakers that virtually eliminates the noise produced by resonating drywall and dramatically improves bass sound quality. Sonafill also reduces room-to-room noise especially in multi-channel installations where many speakers are installed.

The Sonafill system consists of two pillows and four tiles. Installation is accomplished by first adhering the tiles to the inside of the cavity, then stuffing the two pillows in place behind the tiles.

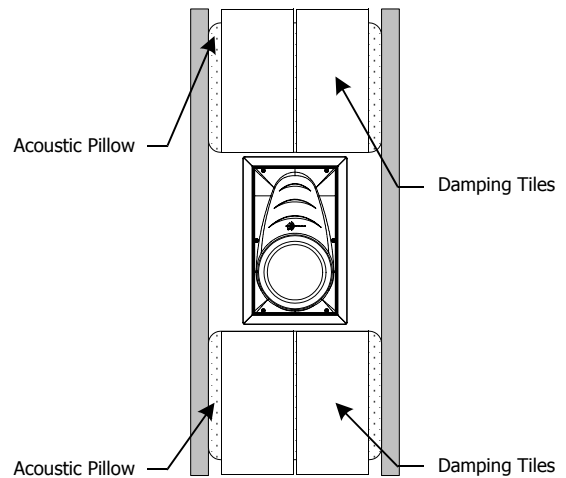

The Sonafill System

## New Construction

The Virtuoso P800D speaker features an integral Roto-Flex™ mounting system for quick mounting into walls. The Virtuoso Fixed Depth Bracket is only necessary in new construction installations when reserving a location for the speaker is desired.

The Fixed Depth Bracket will serve as a guide for the drywall when cutting holes for in-ceiling speakers. The Fixed Depth Bracket is nailed or screwed to the studs so that the hole is in the desired location once the drywall is installed.

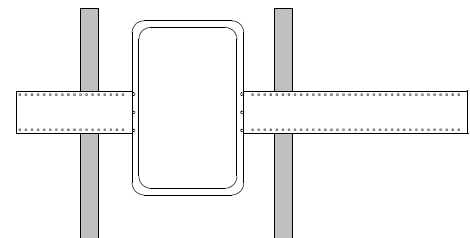

Virtuoso Fixed Depth Bracket

## Retrofit

With the Roto-Flex system, the speaker can be installed directly into existing walls. Once the hole is cut and the cable is run, the speakers can be installed in a matter of seconds.

Once you have determined the area you would like to locate your speakers, you will need to do an obstruction survey. Before you cut the hole for the speaker, be certain no joist, conduit, pipe, heating duct or air return will interfere with the speaker.

The Virtuoso P800D speaker requires a hole that is 8-3/8" x 14-3/8". There must also be 3-3/4" of depth within the wall for the speaker.

A cut out template is provided in the packaging of the speaker. Position the template where the speaker is to be located and pencil an outline on the ceiling. If you are unsure about obstructions drill a small hole in the center of the circle and insert a coat hanger into the hole to feel for possible obstructions. If no obstructions are found, proceed with cutting the hole using a drywall saw and run the speaker wires.

## INSTALLING THE SPEAKERS

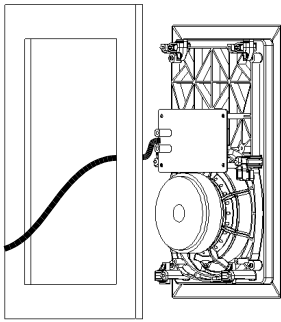

### Step 1

Remove the paint plug from the speaker. Attach the wire from your amplifier to the terminals on the back of the speaker. Double check the polarity of the speaker wires, amplifier + to speaker + and amplifier - to speaker -. Proper polarity is critical in home theater installations.

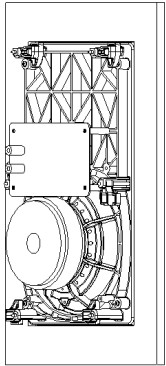

### Step 2

Make sure the Roto-Flex clamps are in the full clockwise position so that all the clamps are tucked within the cutout border. Insert the speaker into the hole in the wall.

Note: The maximum clamp thickness is 1-1/4" (32mm)

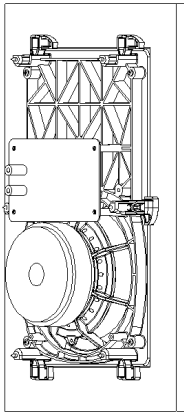

### Step 3

Tighten the six screws on the front of the baffle. The Roto-Flex clamps will rotate into position automatically and begin clamping. When you notice resistance on the four screws, the speaker has been clamped successfully.

The flange is designed to flex and conform to any small imperfections in the wall surface. The screws should not be tightened so far that the flange bows out.

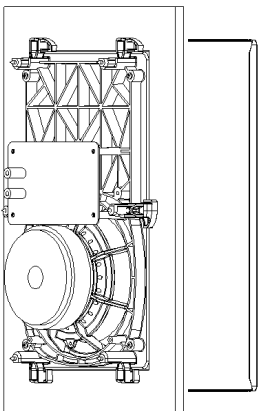

### Step 4

After the speaker is clamped to the drywall the grille can be installed. Insert about half of the grille into the groove at the edge of the speaker. Gently fit the remaining half of the grill into the speaker by working your hands around the speaker fitting the grille into the groove as you go along.

Note: The torque applied to the mounting screws can be adjusted for proper grille fit.

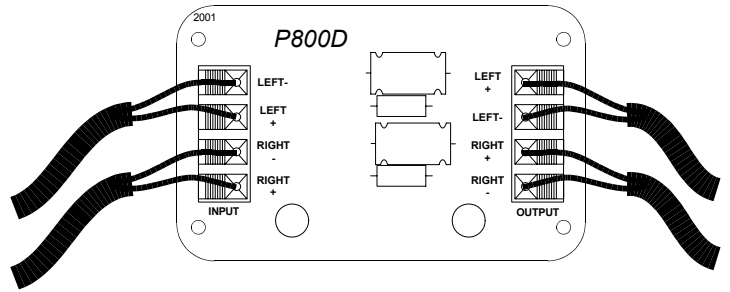

## CONNECTING THE P800D

### Input

The wires from your amplifier or receiver connect on this side of the crossover. Double check that the left and right positive and negative wires are connect to there appropriate terminals.

### Output

The wires to your main or satellite speakers connect on this side of the crossover. Once again double check that the left and right positive and negative wires are connect to there appropriate terminals.

## PAINTING THE SPEAKERS AND GRILLES

Speakers and grilles can be painted before installation, which will eliminate the "paint scar" if the speaker needs to be removed for service. Speakers may also be painted after installation, but before the grilles are attached. All speakers come from the factory fitted with a plastic "paint plug." Use the paint plug to protect the drivers while the flange is being painted with the ceiling.

Sonance suggests always painting the grilles separate from the speaker. The grilles may be lightly sprayed with thin paint (5 parts thinning agent to 1 part paint), but be careful not to plug the holes. Too much paint will adversely affect the sound of the speaker.

Once the grilles and flange are painted and dry, remove the paint plug from the flange and install the grilles.

## P800D

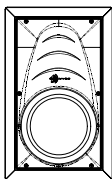

Speaker Design	In-wall infinite baffle passive woofer
Woofer	8" (203 mm) Aluminum cone, dual voice coil and rubber surround
Frequency Response	40 hz to 150 hz
Impedance	6 ohms nominal
Power	5 to 150 watts
Efficiency	90 dB 1W / 1m
Grilles	Aluminum
Dimensions WxHxD	10.0" (254mm) x 16 1/16" (408mm) x 3 7/8" (99mm)
Cutout Dimensions	8 3/8" (213mm) wide x 14 3/8" (365mm) tall
Weight	9.5 lbs (4.3 kg) each

## TECHNICAL ASSISTANCE AND SERVICE

The Technical Assistance Department at Sonance is available at (800) 582-0772 or (949) 492-7777 to answer any questions concerning the operation and installation of your speakers between the hours of 9:00 AM and 5:00 PM Pacific time, Monday through Friday, except holidays.

In the event your unit should need repair or service, you may return the unit to your authorized dealer or use the following guidelines:

1. Be prepared to state the model number and / or serial number, date of purchase and dealer's name and address when calling.
2. Contact Sonance directly at (800) 582-0772 or (949) 492-7777 or at [www.sonance.com](http://www.sonance.com)
3. If you are returning the product directly to Sonance, call us to obtain a return authorization number before shipping. **YOU MUST HAVE PRIOR AUTHORIZATION TO RETURN YOUR UNIT.**
4. The original packaging must be used. If the original packaging is unavailable, replacements can be obtained from Sonance for a small fee.
5. Ship the product via United Parcel Service, Federal Express, or RPS. Please do not use the U.S. Mail service.
6. Write the return authorization number on the outside of the box.
7. Ship to:  
Attn: Quality Assurance Department  
Sonance  
212 Avenida Fabricante  
San Clemente, CA 92672-7531
8. **FREIGHT COLLECT SHIPMENTS WILL BE REFUSED !**

## WARRANTY COVERAGE ( U.S. ONLY )

If, within five (5) years from the date shown on the bill of sale, the unit fails due to a defect in workmanship or material, Sonance will, at its option and at no charge, repair or replace the components of such unit which prove to be defective. For this warranty to be effective, the bill of sale must show that the unit was purchased from an "Authorized Sonance Dealer" and must list the price paid. This warranty shall apply exclusively to the original purchaser and shall not apply to units purchased for industrial or commercial use.

Furthermore, this warranty shall not apply if:

1. Damage to the unit was caused by accident, abuse or misuse;
2. The unit was opened, modified, or repaired by unauthorized personnel.
3. The unit was not used as outlined in the operating instructions.

## EXCLUSIONS AND LIMITATIONS

The warranty set forth above is in lieu of all other warranties, expressed or implied, of merchantability, fitness for a particular purpose, or otherwise. The warranty is limited to Sonance products registered herein and specifically excludes any damage to loudspeakers and other allied or associated equipment which may result for any reason from use with this product. Sonance shall in no event be liable for incidental or consequential damages arising from any breach of this warranty or otherwise. This warranty gives you specific legal rights, and you may have rights which vary from state to state.